



Maxxus Infrared Sauna Instruction Manual

Models: MX-K206-01/MX-K306-01/MX-K406-01
2, 3 and 4 Person FAR Infrared Saunas



Owner's Manual

CARBON MODEL SAUNA

MX-K206-01 - 120VAC 15AMP Dedicated Circuit Required

MX-K306-01/MX-K406-01 - 120VAC 20AMP Dedicated Circuits Required

Carefully and thoroughly read this Owner's Manual before using/operating the sauna. We recommend keeping this Owner's Manual for regular review and future reference. Follow your local codes and ordinances.

TABLE OF CONTENTS

Packing List	2
Visual Assembly Diagrams	6
Parts Description	9
Dimensional Diagram	12
Screw Identification	15
Highlights	18
Assembly	19
Operating the Sauna	25
Tips for Using Your Sauna	28
Safety Instructions	29
Safeguards for Your Sauna	30
Troubleshooting Guide	31
Warranty	33
Warranty Card	35

WARNING: Visually inspect all heaters before assembly to make sure they are not damaged. Any excessive vibrations during transport could cause damage to the heating elements. DO NOT START the sauna if damage is detected! Contact your dealer or manufacturer for troubleshooting and replacement parts.

Packing List (main panels)

1pc Front Panel	1pc Rear Panel	1pc Right Side Panel
1pc Left Side Panel	1pc Roof Panel	1pc Roof Cover
1pc Bench	1pc Bench Heat Emitter Panel	1pc Floor Panel

NOTE: Your model sauna has been completely assembled and tested prior to packaging. The rear wall panel is intentional warped as part of the overall design. Two adults will be needed to assemble the sauna room.

CAUTION: Exit Sauna Immediately If You Feel Dizzy, Sleepy, Or Any Discomfort.

The information provided in this Owner's Manual is for informational purposes only and may not be construed as medical advice or instruction. The information is not recommended for any particular treatment and in all cases, it is recommended that you consult with your medical physician before using. This product does not constitute or imply any medical endorsement. The pictures and diagrams shown within this Owner's Manual are representations of this model(s). Actual model may vary.

What Are Infrared Rays?

Infrared is the band of light we perceive as heat. We cannot see this band of light with the naked eye, but we can feel this type of light in the form of heat. Our sun produces most of its energy output in the infrared segment of the spectrum. Infrared rays heat your body without having to heat the air in-between. This process is called conversion.

The infrared is divided into 3 segments by wavelengths measured in microns: Near Infrared – 0.76-1.5 microns; Middle Infrared – 1.5-5.6 microns; and Far Infrared – 5.6-1000 microns. Among these segments, Far Infrared penetrates organic substances such as the human body two to three inches so that the warming effect is very uniform.

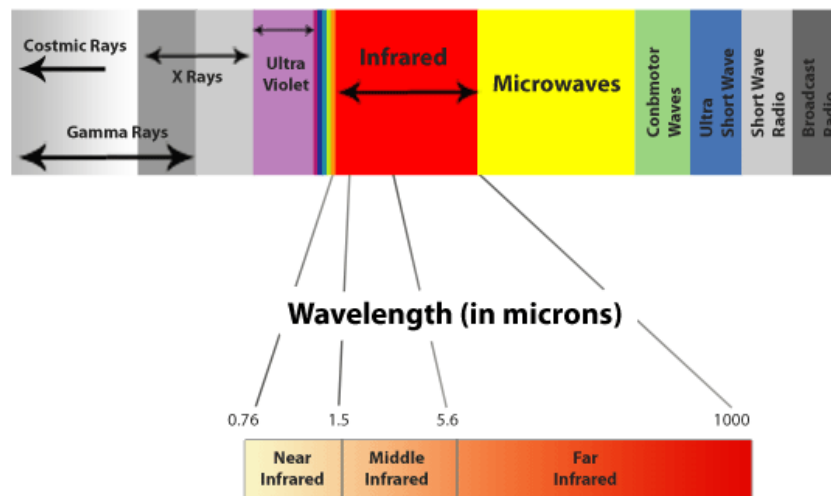

ARE INFRARED RAYS SAFE?

Because infrared rays are part of sunlight, they are not only safe but also highly beneficial to our bodies on a cellular level. Health professionals have used infrared heat lamps for decades to **treat muscle and joint problems**. In hospital baby care units, incubators are often equipped with infrared heating systems to **keep newborn babies warm**.

WHAT IS AN ELECTROMAGNETIC FIELD (also known as EMF)?

An Electromagnetic Field is a physical field produced by electrically charged objects. It is one of the fundamental forces of nature. The field can be viewed as the combination of an electric field and a magnetic field. The electric field is produced by stationary charges and the magnetic field by moving charges referred to as currents. The magnetic field is measured in milligauss (mG). Our sauna products have been developed to have low EMF. Our Low EMF sauna models range between an average of 5mG-10mG at about two inches from the heater panel and our Ultra Low EMF sauna models range between 3mG-5mG at the same approximate distance.

EMF Levels from Common Homes Sources

SOURCE	mG up to 4 inches	mG at 3 feet
Blender	50-220	0.3-3
Clothes Washer	8-200	0.1-4
Coffee Maker	6-29	0.1
Computer	4-20	2-5
Flourescent Lamp	400-4,000	0.1-5
Hair Dryer	60-20,000	0.1-6
Microwave Oven	100-500	1-25
Television	5-100	0.1-6
Vacuum Cleaner	230-1,300	3-40
Airplane	50	

Source: USA Environmental Protection Agency

After many years and numerous studies on EMF exposure, no government body including the Occupational Safety and Health Administration (OSHA) have established permissible exposure limits (PEL). Currently, there is no consensus on the potential health hazard from any exposure to EMF. The mainstream scientific evidence suggests that low-power, low-frequency, electromagnetic radiation associated with household currents like that of the infrared sauna does not constitute a short or long term health hazard.

DISCLAIMER

The infrared rays emitted by your sauna are reported to offer a wide range of possible therapeutic benefits based on research completed over the last 40 years from all around the world. These benefits are presented for reference purposes only and no implication of infrared saunas creating a cure for or treating any disease is implied nor should it be inferred. If you have a medical/health condition, are taking prescription drugs, or have acute joint injuries, please consult with your medical physician before using the sauna. Persons with surgical implants (metal pins/rods, artificial joints, silicone, or other types of surgical implants) typically do not experience any adverse effects, but should also consult their medical physician or surgeon before using the sauna room.

HOW IT WORKS

Infrared Saunas differ from traditional saunas in that they use infrared radiant energy to directly penetrate into the body's tissue to produce perspiration. Traditional saunas use steam to heat the air inside the sauna, which then heats your body until you begin to perspire. In order for this to be effective, temperatures would need to reach in the upwards of 190 degrees Fahrenheit. Infrared saunas only need a temperature of up to 120 degrees Fahrenheit to obtain the same effect. This lower temperature makes the environment more tolerable and allows you to breathe easier.

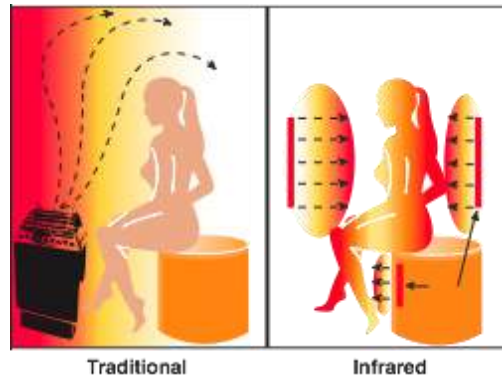

Health Benefits

Because infrared rays penetrate the body through convection, there is a deep heating effect in both the muscle tissues and internal organs without putting too much burden on the heart.

Our body reacts to the increased heating through the natural cooling process of perspiring. Through the perspiration process, acid and waste residue like toxins, sodium, alcohol, nicotine, cholesterol, and the potentially carcinogenic heavy metals are removed from the cells (especially zinc, lead, nickel, cadmium, etc.). The pores of our skin open and discharge waste products shedding any old skin cells leaving the skin glowing and clean, with improved tone, elasticity, texture, and color.

Health Benefits Include, But Are Not Limited To:

- | | | |
|--|---------------------------|---------------------|
| *Pain relief from Rheumatoid Arthritis | *Relaxes muscle spasms | *Reduces cellulite |
| *Increases blood circulation | *Clears, rashes, acne | *Enhances skin tone |
| *Cardiovascular conditioning | *Reduces stress & fatigue | *Removes toxins |

Sauna Maintenance

Since infrared saunas do not require hot rocks, water, or steam to operate, they require very little maintenance. You can simply wipe it down with water – use a damp, soft, and clean cloth. **Do not use any chemical based cleaning agents** as they can be absorbed into the wood and be released into your sauna during use.

PLEASE READ INSTRUCTIONS BEFORE ASSEMBLY

Visual Assembly Diagram

MX-K206-01 (SJ-8223)

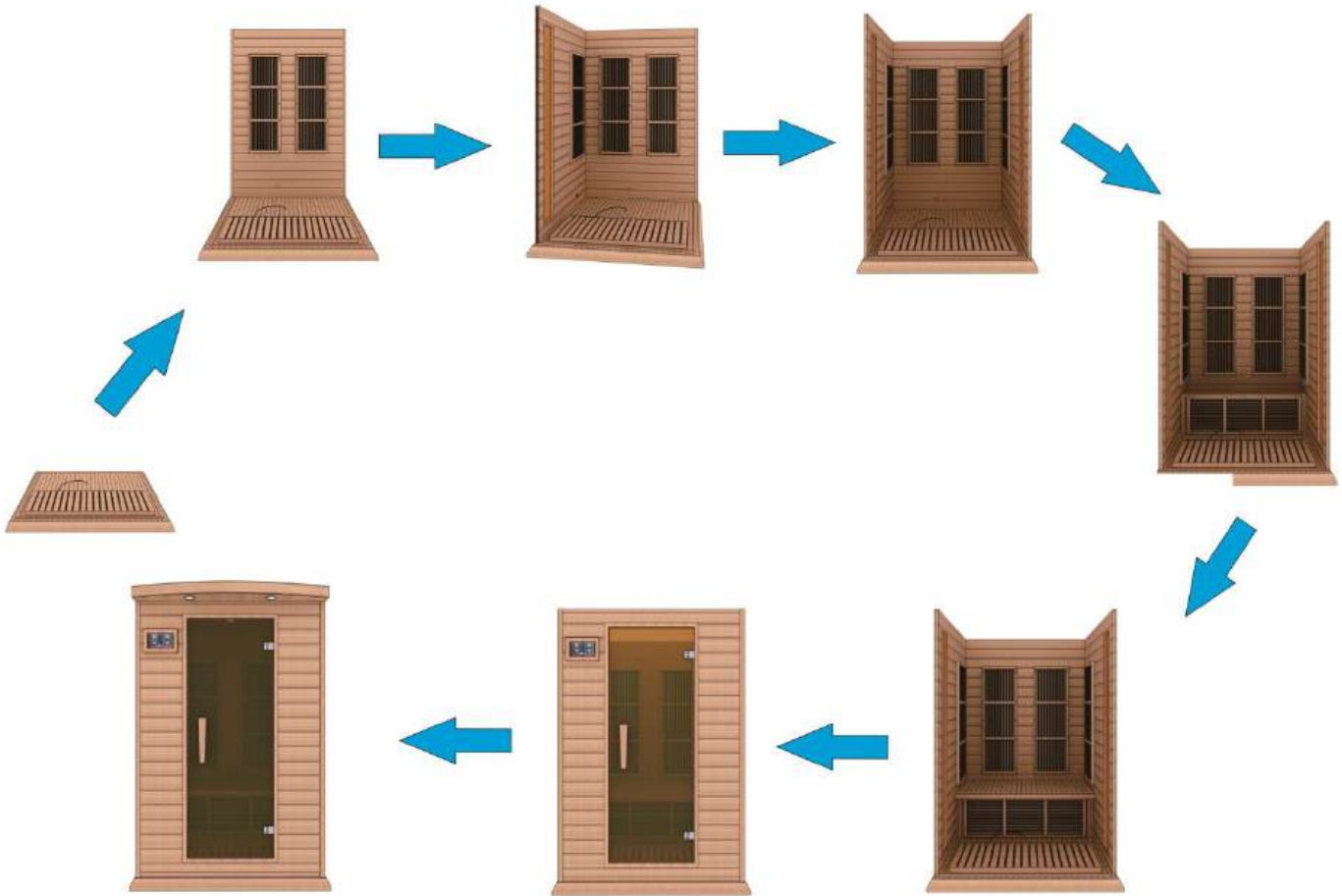

***The above assembly diagrams are for quick reference visual guides only. All sauna models are not shown. Parts and accessories may vary. Parts subject to change.**

PLEASE READ INSTRUCTIONS BEFORE ASSEMBLY

Visual Assembly Diagram

MX-K306-01 (SJ-8323)

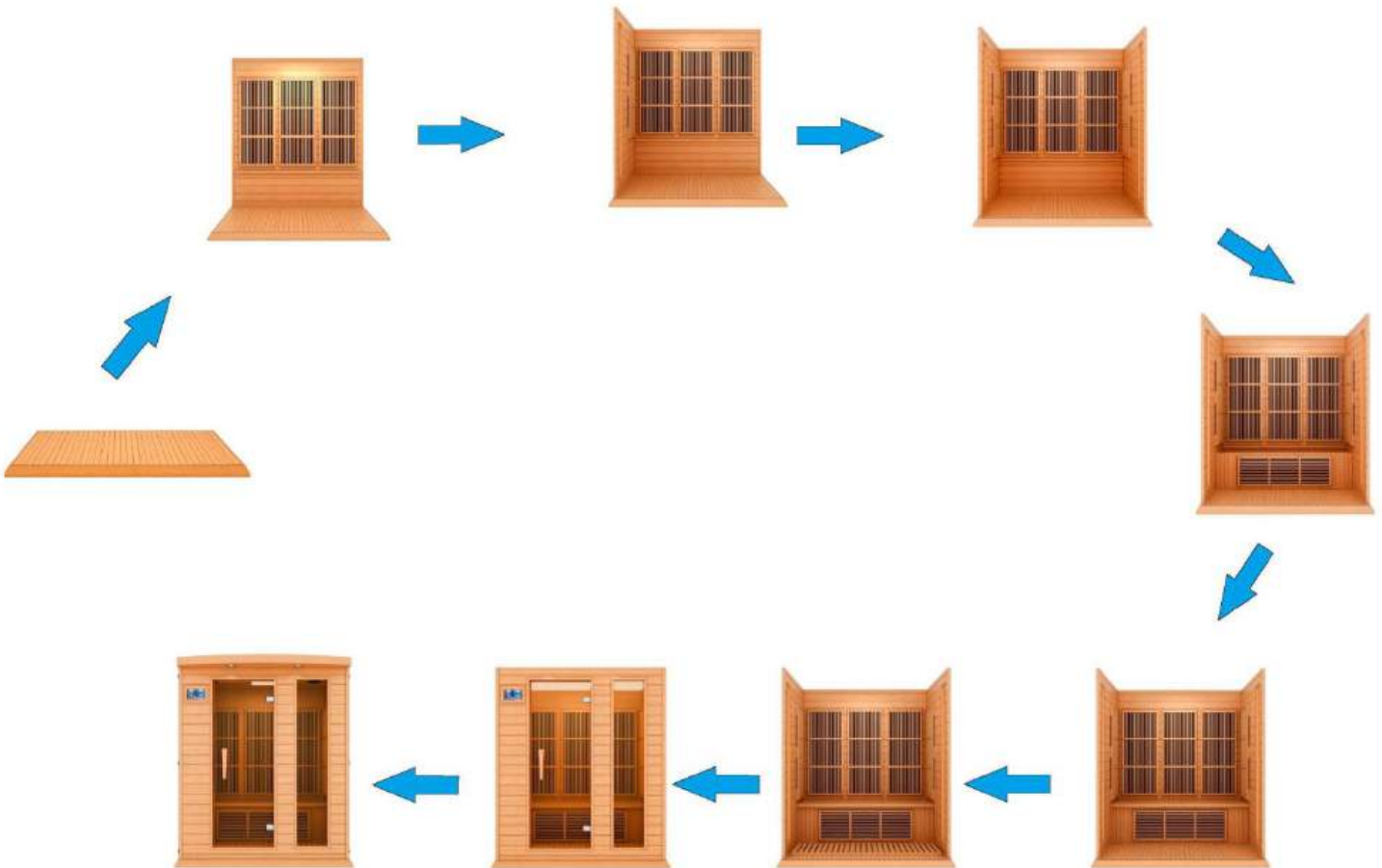

***The above assembly diagrams are for quick reference visual guides only. All sauna models are not shown. Parts and accessories may vary. Parts subject to change.**

PLEASE READ INSTRUCTIONS BEFORE ASSEMBLY

Visual Assembly Diagram

MX-K406-01 (SJ-8423)

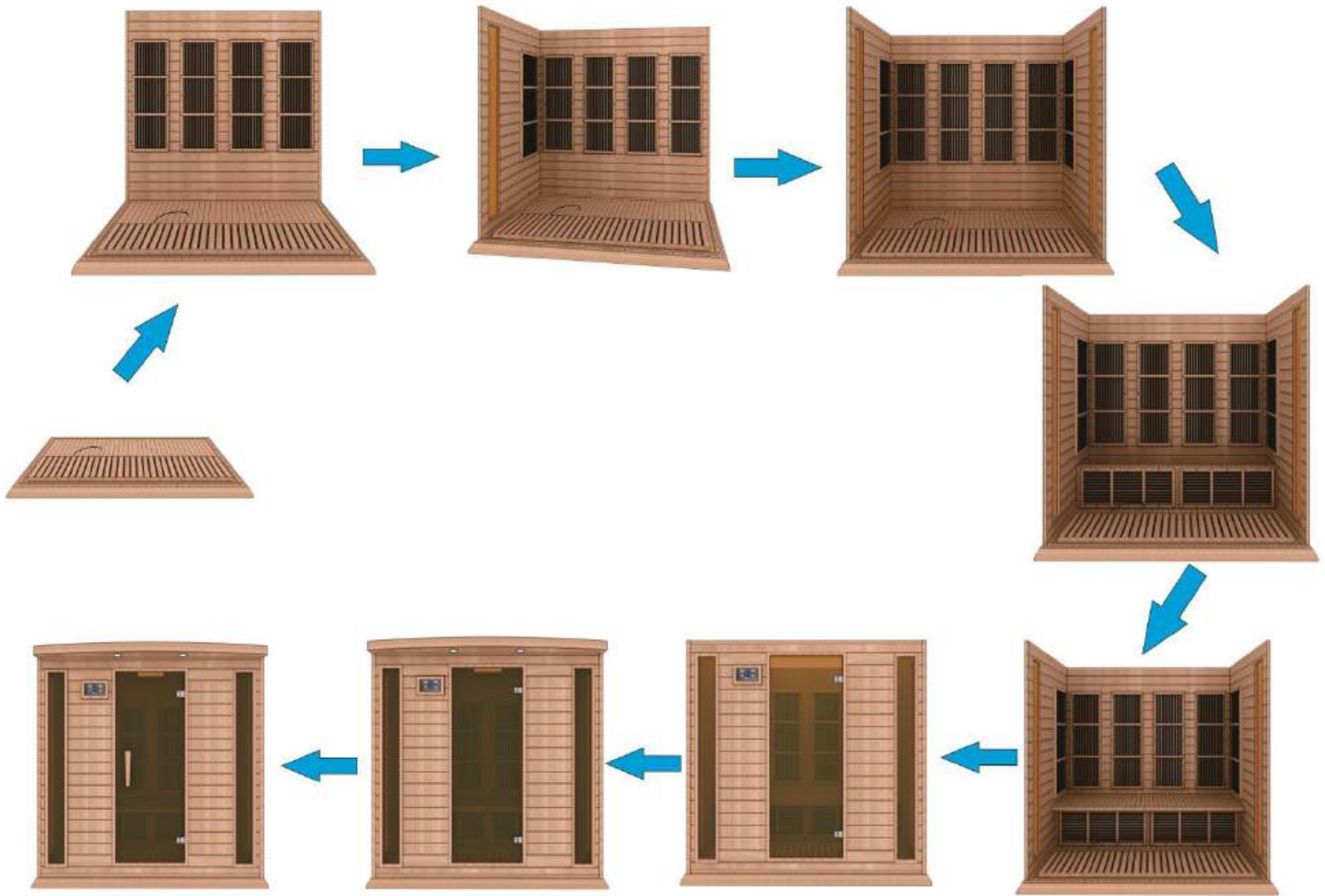

***The above assembly diagrams are for quick reference visual guides only. All sauna models are not shown. Parts and accessories may vary. Parts subject to change.**

PARTS DESCRIPTION

MX-K206-01 (SJ-8223)

Electronic components			
No.	Name	No.	Name
1	power supply	2	DC LED Light (Exterior light)
3	Speaker	4	CD/Radio
5	Color light	6	DC LED Light (color light)

Power layout			
Location	No.	Dimension	Power
Left wall panel	6	1000*300mm=4PCS	300W
Right wall panel			
Rear wall panel			
Heater bench panel	7	1000*300mm=1PCS	200W
Floor heater	8	1000*340mm=1PCS	300W

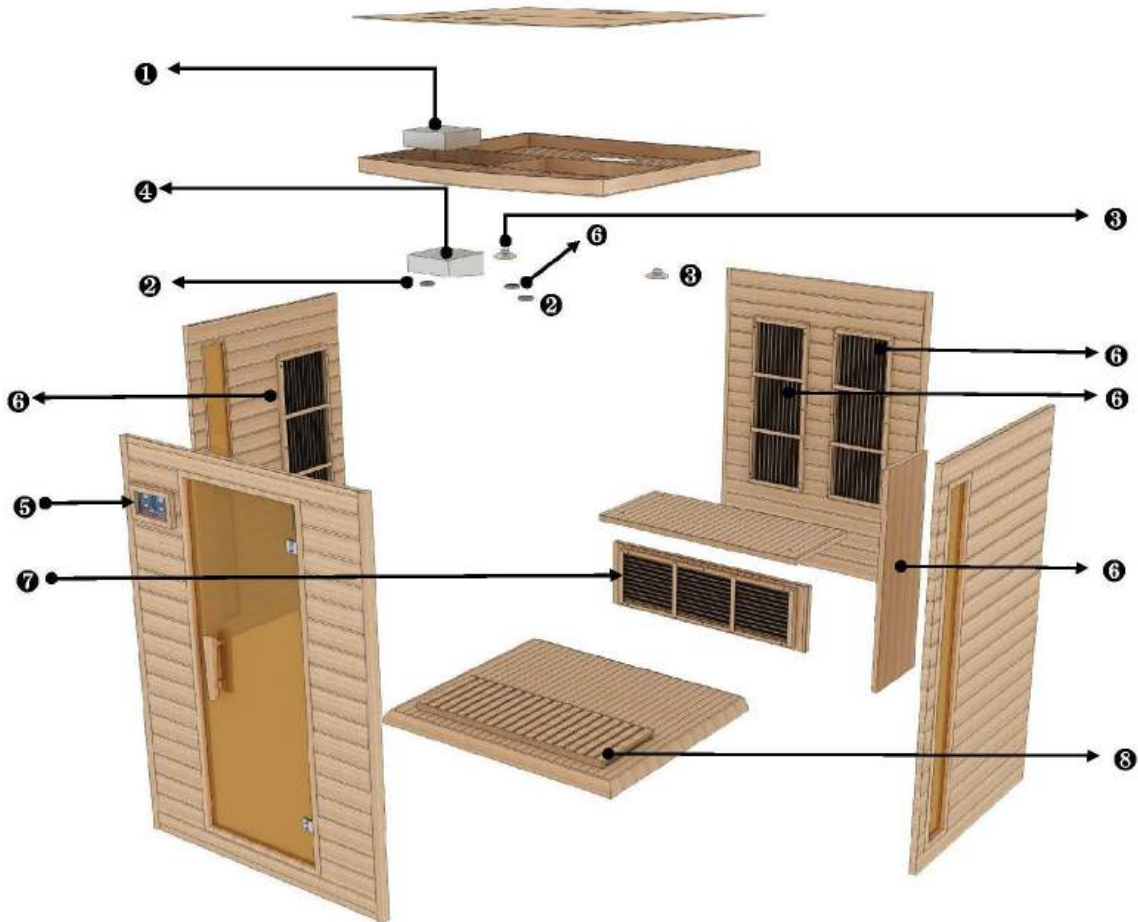

***The above assembly diagrams are for quick reference visual guides only. All sauna models are not shown. Parts and accessories may vary. Parts subject to change.**

PARTS DESCRIPTION

MX-K306-01 (SJ-8323)

Electronic components			
No.	Name	No.	Name
1	Power supply	2	Color light
3	Speaker	4	Control panel
5	Temperature sensor	6	CD/Radio

Power layout			
Location	No.	Dimension	Power
Left wall panel	7	1000*300mm=5PCS	300W
Right wall panel			
Rear wall panel			
heater bench panel	8	1000*300mm=1PCS	300W
Floor heater	9	1000*340mm=1PCS	300W

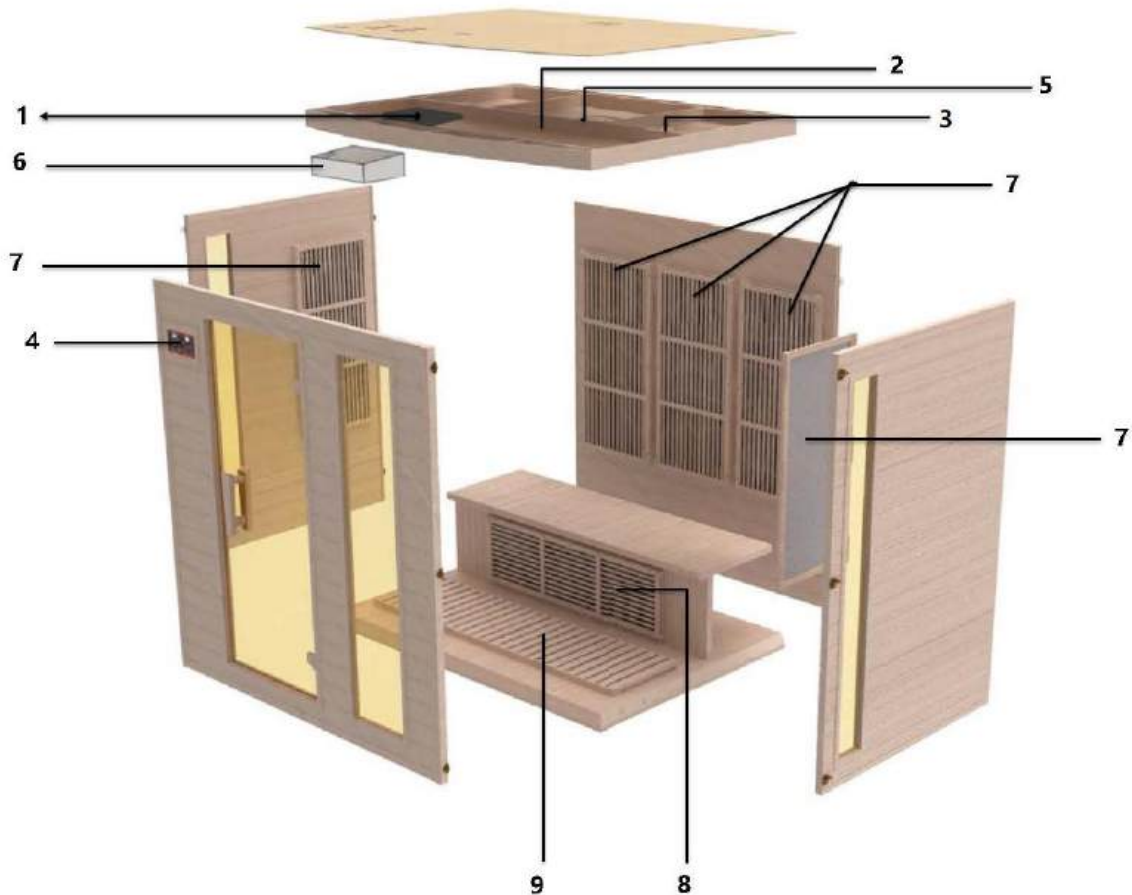

***The above assembly diagrams are for quick reference visual guides only. All sauna models are not shown. Parts and accessories may vary. Parts subject to change.**

PARTS DESCRIPTION

MX-K406-01 (SJ-8423)

Electronic components			
No.	Name	No.	Name
1	Power supply	2	LED DC exterior light,
3	Speaker	4	CD/Radio
5	Control panel	6	Color light

Power layout			
Location	No.	Dimension	Power
Left wall panel	7	1000*300mm=1PCS	300W
Right wall panel	7	1000*300mm=1PCS	300W
Rear wall panel	8	1000*300mm=2PCS	200W
	9	1000*300mm=2PCS	300W
Heater bench panel	10	700*300mm=2PCS	200W
Floor heater	11	1000*340mm=1PCS	160W

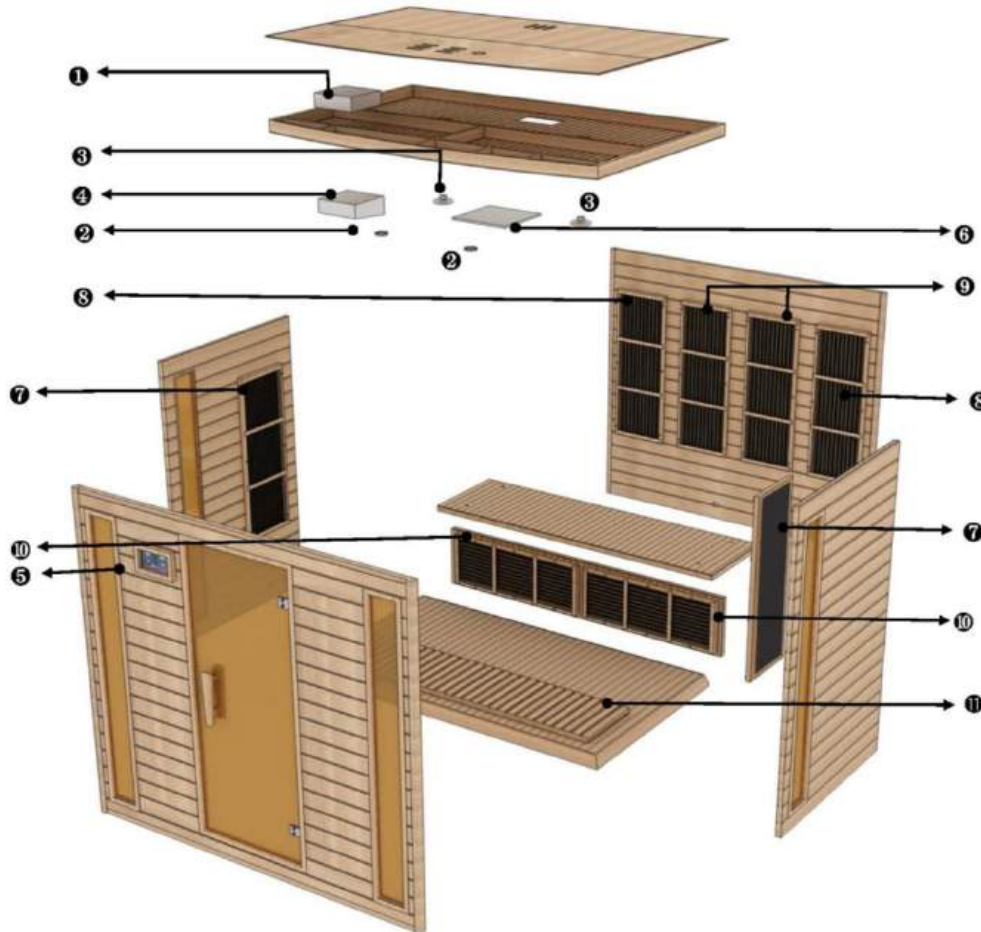

***The above assembly diagrams are for quick reference visual guides only. All sauna models are not shown. Parts and accessories may vary. Parts subject to change.**

DIMENSTIONAL DIAGRAM

MX-K206-01 (SJ-8223)

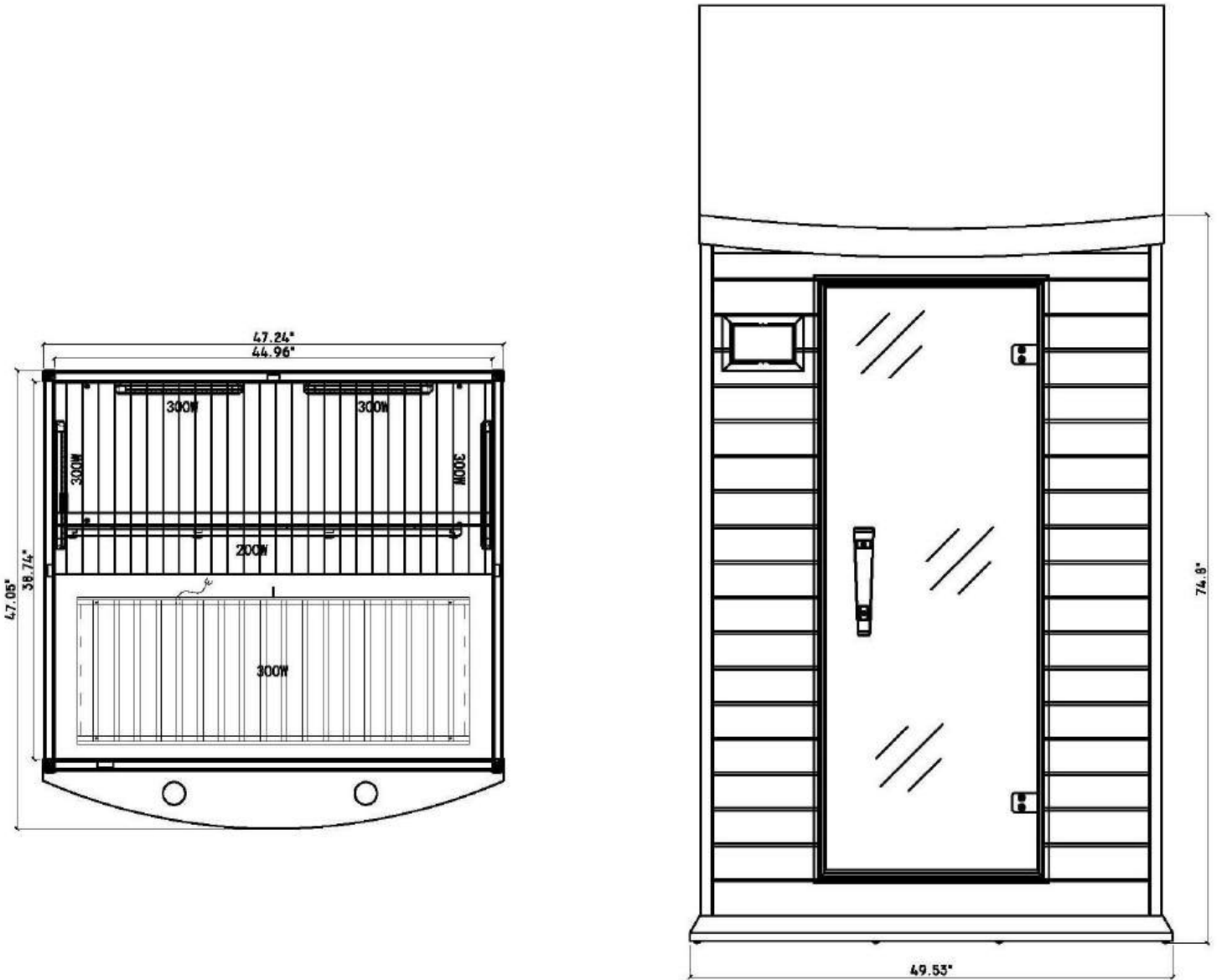

***The above assembly diagrams are for quick reference visual guides only. All sauna models are not shown. Parts and accessories may vary. Parts subject to change.**

DIMENSIONAL DIAGRAM

MX-K306-01 (SJ-8323)

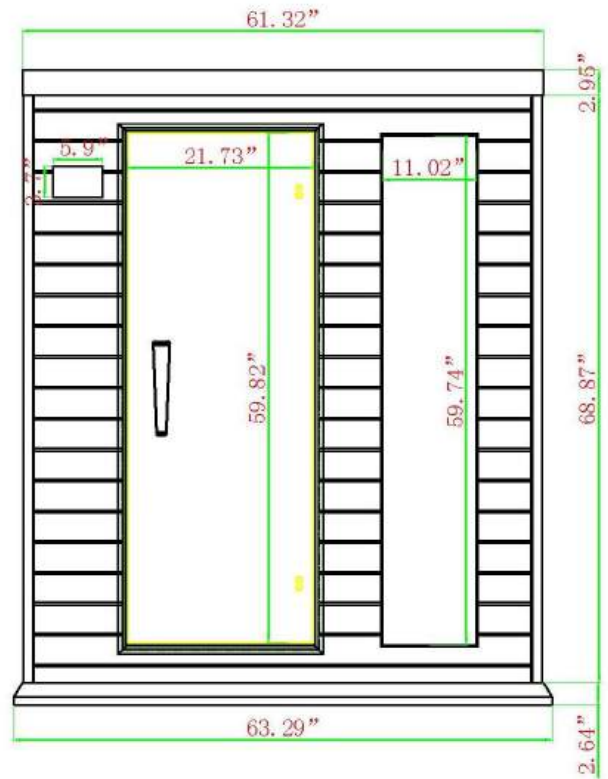
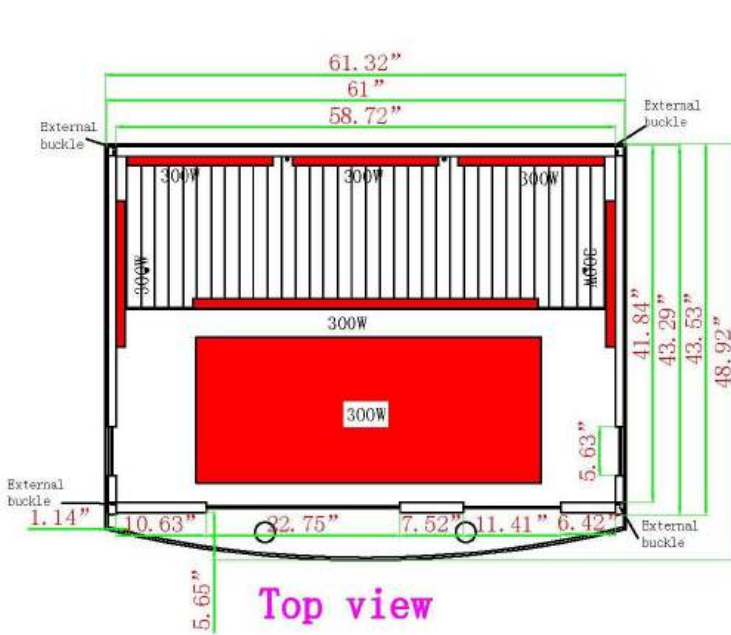

*The above assembly diagrams are for quick reference visual guides only. All sauna models are not shown. Parts and accessories may vary. Parts subject to change.



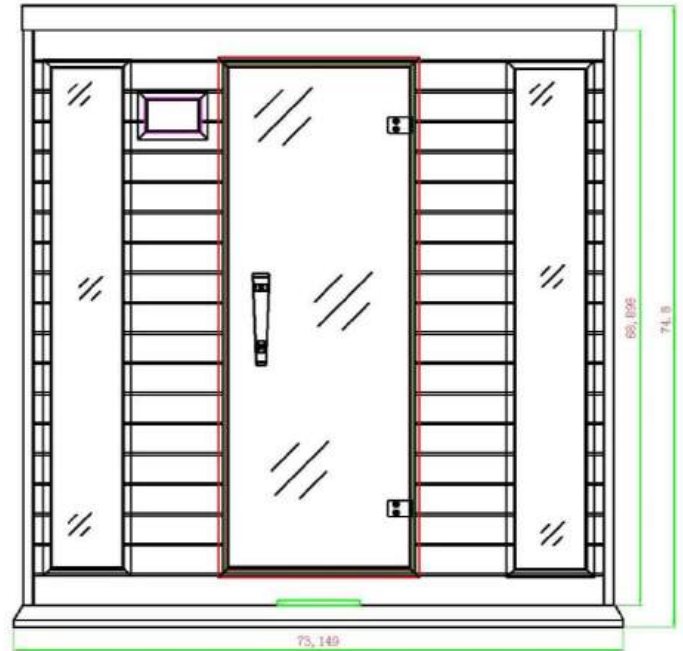
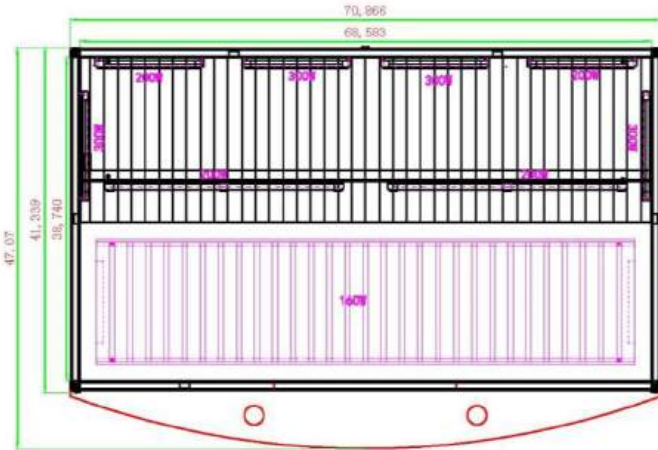

DIMENSTIONAL DIAGRAM

MX-K406-01 (SJ-8423)







*The above assembly diagrams are for quick reference visual guides only. All sauna models are not shown. Parts and accessories may vary. Parts subject to change.





SCREW IDENTIFICATION

Item#	Image	Parts List for MX-K206-01
1		Door handle spacer: 4pcs
2		(4*35mm) Screws for floor heater panel: 4pcs
3		(3*18mm) Screws for CD antenna: 4pcs Screws for roof dust cover: 16pcs
4		(5*50mm) Screws for roof wall panel: 5pcs Screws for bench: 4pcs
5		(3*25mm) Screws for CD wood cover: 2pcs

SCREW IDENTIFICATION

Item#	Image	Parts List for MX-K306-01
1		Door handle spacer:4pcs
2		(4*35mm) Screws for floor heater panel: 4pcs
3		(3*18mm) Screws for CD antenna: 4pcs Screws for roof dust cover: 24pcs
4		(5*50mm) Screws for roof wall panel: 5pcs Screws for bench:4pcs
5		(3*25mm) Screws for CD wood cover: 2pcs

SCREW IDENTIFICATION

Item#	Image	Parts List for MX-K406-01
1		Door handle spacer:4pcs
2		(4*35mm) Screws for floor heater panel: 4pcs
3		(3*18mm) Screws for CD antenna: 4pcs Screws for roof dust cover: 16pcs
4		(5*50mm) Screws for roof wall panel: 5pcs Screws for bench:4pcs
5		(3*25mm) Screws for CD wood cover: 2pcs

Highlights

- A. High quality craftsmanship
- B. Temperature control
- C. Timer
- D. Infrared carbon heat emitter panels
- E. Control Panel:



- F. Power supply:



- G. MP3 Jack:



- H. Buckles:

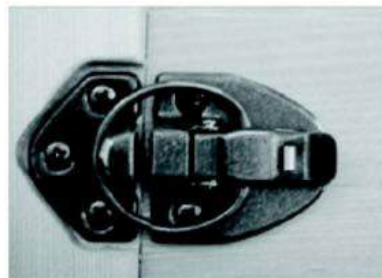

Assembly

Pictures shown are for representation only and may not resemble your exact model.

Please note the following:

- A.** You will need a Philips screwdriver, ladder, and two adults to assemble.
- B.** Do not plug any other appliances into the power supply of the sauna room other than the designated sauna connections/plugs.
- C.** Assemble the sauna room on a completely level surface.
- D.** Do not spray or get water on the exterior/interior walls of the sauna room. If the floor which the sauna will sit on is damp or wet, install a barrier between your floor and the sauna floor to keep the sauna's floor from becoming damp or wet.
- E.** Do not store flammable objects or chemical substances near the sauna.
- F.** 2-person and 3-person saunas are packed into two-to-three cartons. For example - C/NO: 002 1 OF 3; C/NO: 002 2 OF 3; C/NO: 002 3 OF 3. (see FIG-1 & 1.2)

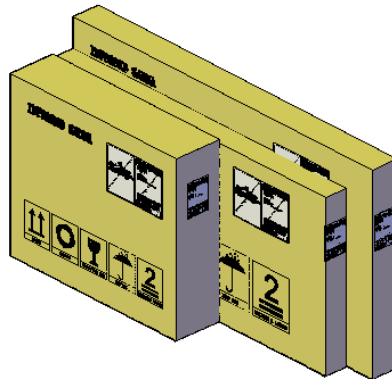

FIG-1 Cartons

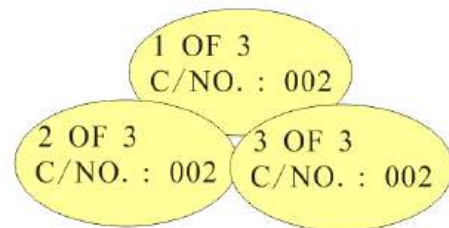

FIG-1.2 C/No.

- 1.** Place the Floor Panel on a smooth/flat/level surface and make sure which side is the front and which side is the back. The front of the floor has **no** quarter round trim molding as do the other three sides. (see FIG-2)

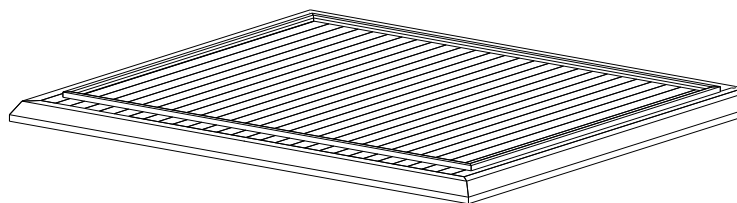

FIG-2 Placing Floor Panel

2. Align the Back Panel with the Floor Panel's corresponding wood pattern; make sure the wood pattern is flowing in the same direction. One person should hold the Back Panel while the other person continues to the next step. **See FIG-3**

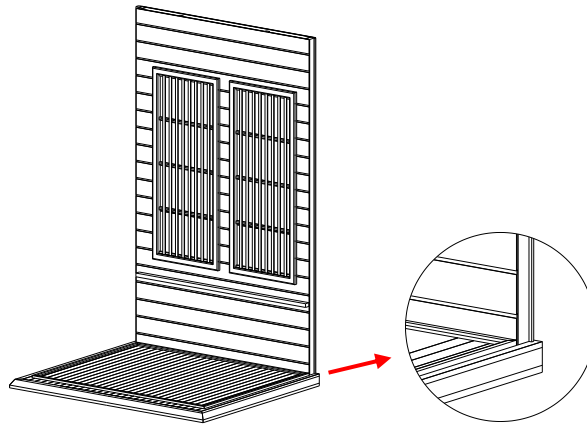

FIG-3 Assembling Back Panel

3. Align the Left Side Panel with the Floor Panel's corresponding wood pattern; make sure the Left Side Panel fits flush into the Back Panel. **See FIG-4**

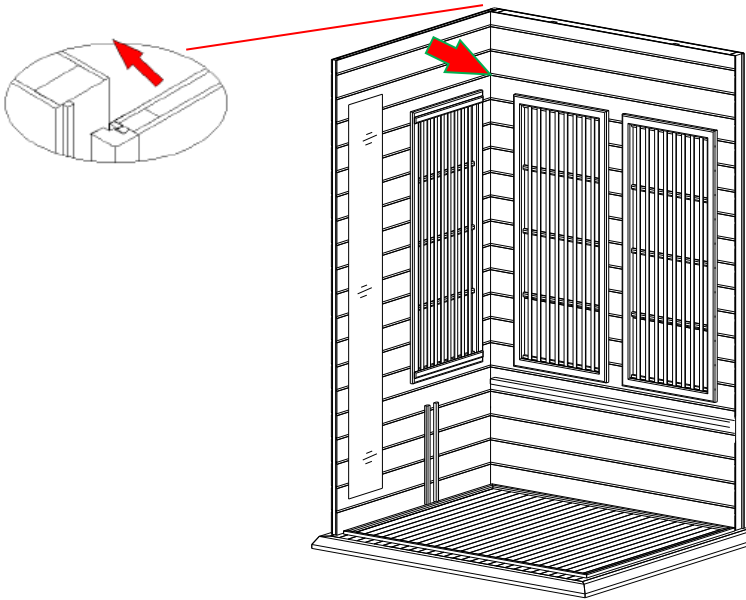

FIG-4 Assembling Left Side Panel

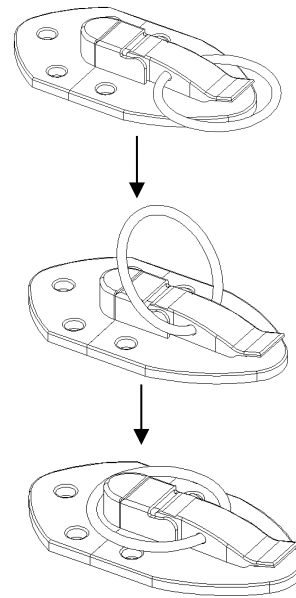

FIG-5 Buckle

4. Latch the Left Side Panel with the Back Panel. The buckle has a guide tab that must be placed in the guide slot for alignment. When the Back Panel and the Side Panel is attached together on the floor panel, make sure all the buckles are latched. **See FIG-5**

5. Align the Right Side Panel with the Floor Panel's corresponding patterns; make sure the Right Panel fits flush into the Back Panel and latch together. **See FIG-6**

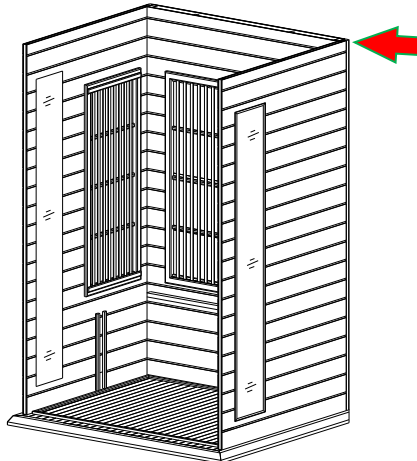

FIG-6 Assembling Right Panel

6. Place the Floor Heater on the Floor Panel making sure that the Floor Heater is in front of the Bench Heater Panel slots. Please note there is a pre-cut small hole under the Bench Heater Panel which is provided for the Floor Heater cord. This cord will connect the Floor Heater to the plug outlet on the Left Side Panel. **See FIG-7 & 8**

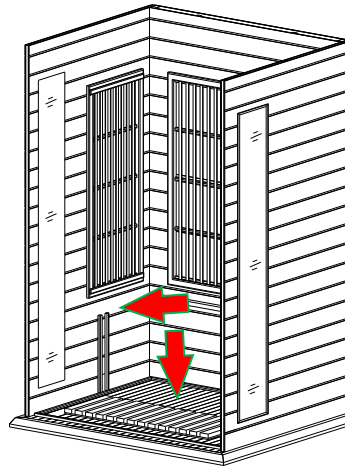

FIG-7 Placing Floor Heater

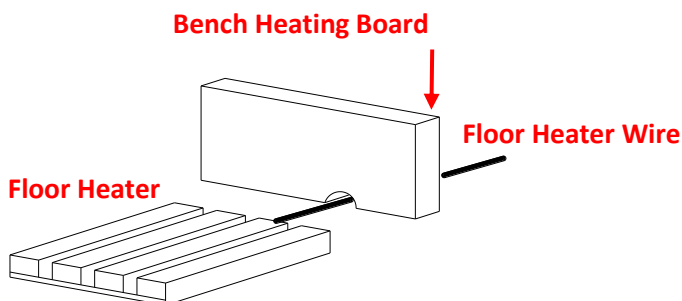
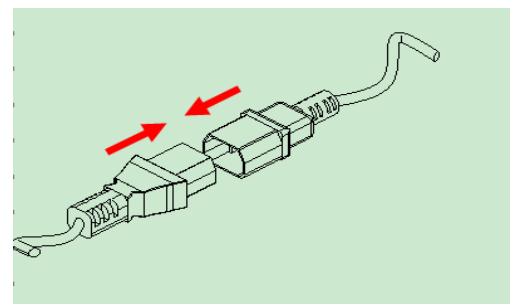

FIG-8 Connect Floor Heater



- The Bench Heater will need to be installed at an angle and brought forward. **See FIG-9.** After installing the Bench Heater, connect the Bench Heater cord with the outlet on the Back Panel and then place the Bench on top of the Bench Heater and slide it into place. Make sure the cords are connected snug and tight. It is optional to use the provided screws to secure the bench in place. **See FIG-10**



FIG-9 Installing Bench Heater

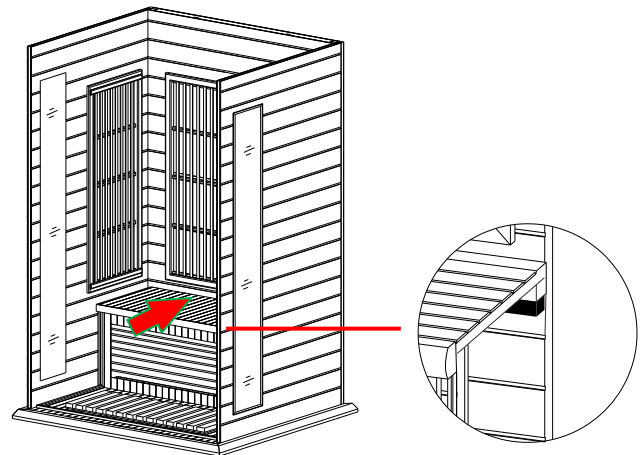

FIG-10 Installing Bench

- Align the Front Panel with the Floor Panel's corresponding patterns; make sure the wood pattern is flowing in the same direction. Next, latch the Front Panel with the Left and Right Side Panels respectively. Note: Be cautious with the glass door to avoid breakage. **See FIG-11.**

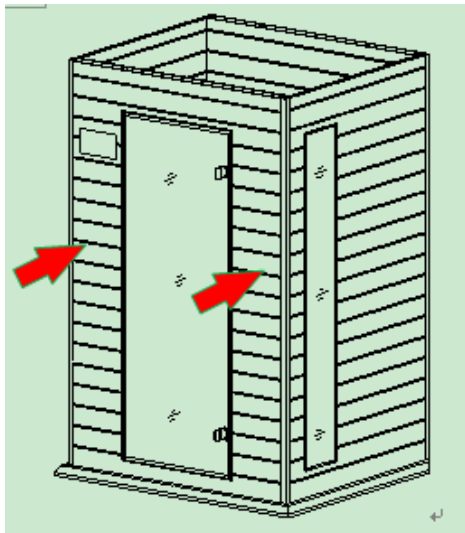

FIG-11 Assembling Front Panel

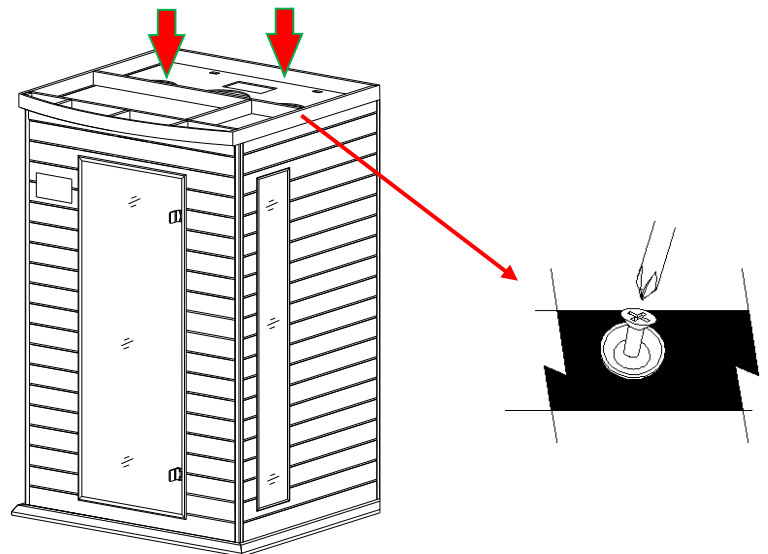

FIG-12 Installing Roof Cover

- Place cords/wires of Front Panel and Back Panel into the sauna room area to avoid damaging the cords/wires during the roof installation. Open the door, lift the Roof Panel up and over the sauna room, and gently lower it into place resting it on the wall panels. Make sure that all cords/wires are slipped through the corresponding holes in the Roof Panel. Proceed in screwing the Roof Panel down. **See FIG-12, 13 & 14**

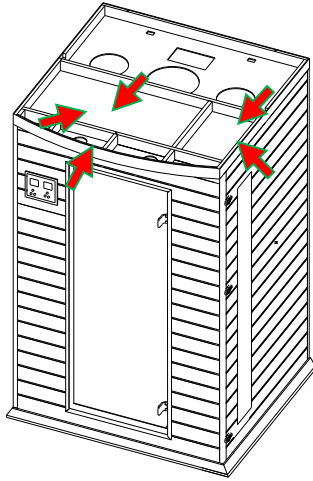

FIG-13 Slip cords/wires through corresponding holes

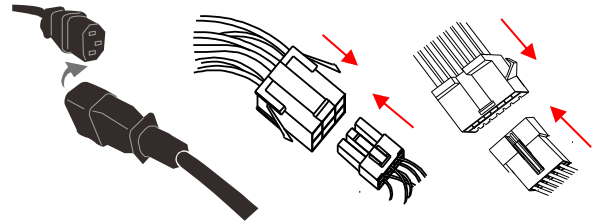
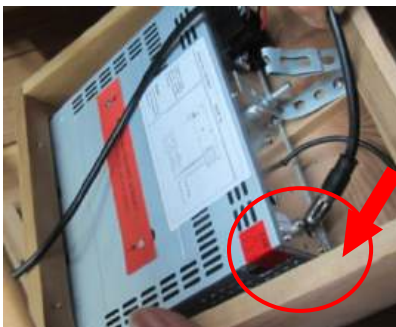

FIG-14 Connecting cords/wires connectors

- Connect all the wires and connectors to the corresponding outlets on the Roof Panel. Please be sure all the plugs are connected snug and tight. **See FIG-14.** Next, pull down the cords/wires of the power plugs of the speakers, temperature sensor, control panel and CD player through the hole near the fan on the Roof Panel.
- The CD Player will already be mounted in its wood housing box. Connect the antenna to the CD player. Next, feed the wires up through the roof. Connect the antenna into the rear of the radio and connect the radio harness up o the roof. **See FIG-15** Next, mount the wood housing box to the ceiling of the sauna room. **FIG-16 and 17.**

Note: CD player may not be available on all model sauna rooms

Step 1



Step 2



FIG-15 Screw CD Player into sauna room



FIG-16 Installing the Radio Wood Housing



FIG-17 Screwing in the Radio Wood Housing

12. Connect the control panel connectors. See FIG-18

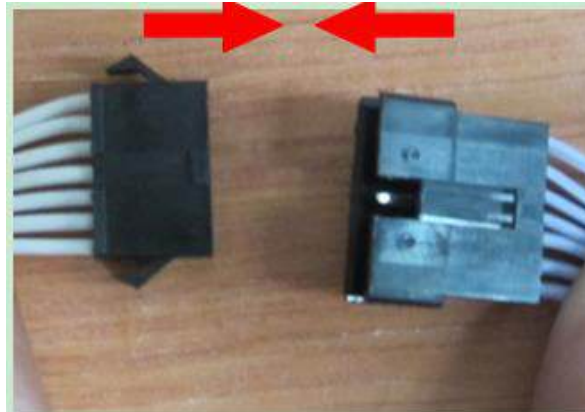

FIG-18 Connecting control panel connectors

13. Make sure all steps are completed correctly. Plug in the power cord to your wall outlet. Turn on the sauna at the control panel to confirm that the control panel is responding. If the control panel responds accordingly, then proceed in putting the Roof Cover onto the Roof Panel. Make sure to pull the power cord through the corresponding hole in the Roof Cover. See FIG-19 & 20

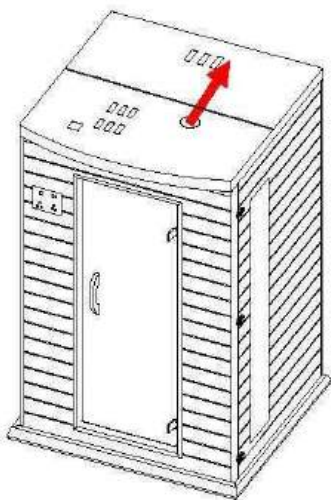

FIG-19 Slip the power cord through Roof Cover

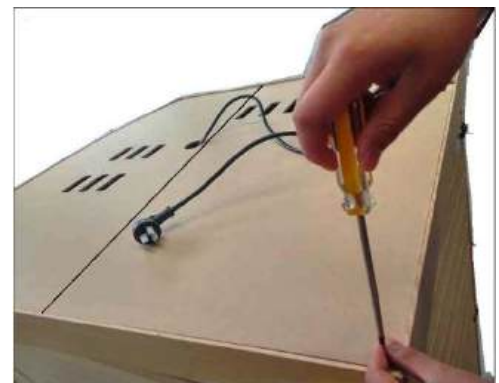

FIG-20 Screw down Roof Cover

14. Screw down the Roof Cover to the Roof. **See FIG-20**

15. Attach the door handle and screw into place. Screw cup-holder and magazine rack to the interior wall panel. (Cup-holder and/or magazine rack are not available on all models.)

Installation Completed.

Operating the Sauna

NOTE: Please check and confirm that the connections to the POWER SUPPLY, HEAT EMITTERS, and TEMPERATURE SENSOR are connected properly. The power supply voltage and frequency must match the requested voltage and frequency of the sauna (120VAC 15AMP Dedicated Circuit or 120VAC 20AMP Dedicated Circuit). This is a residential /semi-commercial appliance. For every (3) hours ON, the unit must have (1) hour OFF.

Since many materials absorb the infrared rays, minimal clothing is recommended for maximum effect. The infrared sauna emitters are designed to heat you and not necessarily the air inside the sauna. It is not a hot box like a traditional sauna. The temperature gauge is a guide for your safety. It is recommended that you drink water before, during, and after sauna use to prevent dehydration since body fluids will be lost through perspiration. It is not recommended to shower after use since the pores in your skin will be open and could possibly absorb anything in the water.







1. Precautions

- a. Please make sure your wall outlet meets the specifications required. Failure to meet the requirements may cause safety risks.
- b. Set the temperature and time to a comfortable level. The average used temperature range is between 118°F – 122°F. The average sauna session is approximately 20 – 30 minutes. **It is recommended that you pre-heat the sauna room to the desired temperature before entering.** Note: If the ambient temperature is below 72°F, the sauna will take longer to pre-heat. It is not recommended to use the sauna in an environment with an ambient temperature below 60°F.
- c. Drink water prior to, during, and after your sauna session to replenish body fluids.
- d. After 3 hours of continuous use, the sauna needs to be shut down for one hour.
- e. To avoid burns, do not touch the heating element.



2. Operating The Sauna



- a. Review the electrical label on the sauna and then plug the sauna into the proper wall outlet. No other appliance can be operated on the same electrical breaker as the sauna when the sauna is in use. Proceed in turning on the sauna room using the ON/OFF button to activate the sauna.
- b. The sauna should be **unplugged** when not in use. If you do not have access to the plug, it is recommended to use a heavy duty surge protector.

- c. **To set the temperature**, press the  temperature buttons to increase or decrease the temperature to the desired temperature. If the “Heat” light is on, the temperature setting will increase one degree every time the  button is pressed. If pressed for three seconds, the setting will increase quickly. Decrease the temperature in the same manner by pressing the  button. After the sauna reaches the desired temperature, the “Heat” light will turn off.

- d. Press the  button to turn the light ON and OFF. If you want to use the **Color Light Therapy System**:

1. While the interior light is ON, press and hold down the  button for 2 seconds. You will notice “2n” in the LED display. This indicates you are in the “light” mode. If you do not press any button for approximately 15 seconds, the “2n” will change back to the Timer mode.

2. While the “2n” is displayed, you can now turn the exterior light ON/OFF by pressing the  button in the  section of the control panel.

3. You can also turn the interior light ON/OFF by pressing the  button in the  section of the control panel.







4. While the interior light is on and the “2n” is still displayed in the LED display, you can press the  button to scroll through the different colors within the Color Light Therapy System. You will notice that you have two selections for “white”:

- A. The first selection for “white” will allow the colors to go through a sequence of the different shades of colors.
- B. The second selection for “white” will continue to display the white light.

5. To return back to the Timer mode, press the  button.

- e. Press the  button to turn the Red Light Therapy ON and OFF. The Red Light Therapy can

operate when the sauna's power is ON or OFF.

- f. You can operate the sauna with the ceiling vent in the open or closed position based on personal preference.
- g. After your sauna session is over, you can turn the control panel off by pressing the ON/OFF button. You can unplug the sauna cord to protect the electronics from power surges.
- h. **To set the time**, press the  buttons. Press  or  buttons to set the timer from 5 to 60 minutes. If pressed for three seconds, the timer will increase/decrease quickly. When the time expires, the timer will buzz and the sauna will shut off automatically. Please note that the light will have to be physically turned OFF if it is ON. To extend the sauna session, reset the timer again by pressing the  buttons.
- i. **The Fahrenheit and Centigrade display** can be switched by pressing and holding the **TEMPERATURE** side buttons  and  at the same time and then pressing the .
- j. **The Bluetooth function** is built into the Control Panel. For the Bluetooth function, you first will need to pair your device with the sauna room. Open your device's Settings Menu and then locate and open Bluetooth. You will find "BT-AUDIO" or "BT-SAUNA". Now you can pair your device. Once pairing is successful, your device will be connected. You will control the volume and choose the music on your device.
- k. **The MP3 Jack** will allow you to connect your musical device using the AUX wire. Plug one end of the AUX wire into your musical device and the other end into the MP3 Jack at the ceiling. Do not leave the AUX wire connected at the ceiling when not using this function as it may cause static interference at the speakers. You will control the volume and choose the music on your device. When you disconnect the MP3 wire, the sound system will automatically return back to the Bluetooth mode.

Please Note: On average, it takes our model saunas approximately:

- *20 minutes to reach into 100 degrees Fahrenheit/38 degrees Celsius (with a starting temperature above 70 degrees Fahrenheit/21 degrees Celsius)**
- *25-30 mins to reach about 115-120 degrees Fahrenheit/46-49 degrees Celsius (depending on sauna model)**
- *35-40 minutes to reach about 125-130 degrees Fahrenheit/52-54 degrees Celsius (depending on sauna model)**
- *45-60 minutes to reach up to approximately 135 degrees Fahrenheit/57 degrees Celsius (depending on sauna model)**

Please keep in mind that you can either preheat the sauna to the set temperature before entering or sit inside the sauna as the temperature rises. In addition, you will increase the time it takes for the sauna to reach the set temperature if you enter the sauna room before it has reached the set temperature. Also, the most commonly used temperature setting is between 118 degrees Fahrenheit / 48 degrees Celsius and 122 degrees Fahrenheit / 50 degrees Celsius. The way the sauna room works is when you set the Control Panel to say 120 degrees F / 49 degrees C, the heat emitters will turn off when that set temperature is reached. And even though the sauna does allow the user to set the Control Panel to 151 degrees F/66 degrees C, this is specifically for those users who do not want the heat emitters to ever turn off as the sauna room will never achieve 151 degrees F / 66 degrees C. After 3 hours of continuous use, the sauna needs to be shut down for one hour.

Use 2 towels during your sauna session. Fold the first towel several times and place it on the bench. As you sit on this towel, it will absorb a majority of your perspiration while adding comfort as you sit on the bench. Use the second towel to either constantly wipe the perspiration from your body to perspire faster and also to avoid having too much perspiration dripping onto the floor. Never place any towels over the floor heater. If your legs become cold, you can use a third towel to drape over your legs to trap the heat.

CAUTION: Exit sauna immediately if you feel dizzy, sleepy, or any discomfort.

Tips for using Your Sauna

1. If you take a hot/warm shower or bath before using your sauna, you may perspire more and experience more comfort.
2. Drink water prior to, during, and after your sauna session to replenish body fluids.
3. To regulate the set temperature inside the sauna to your comfort level, use the movable roof vent or leave the door slightly open. The roof vent is installed on the sauna and used based on personal preference.
4. Use 2 towels during your sauna session. Fold the first towel several times and place it on the bench. As you sit on this towel, it will absorb a majority of your perspiration while adding comfort as you sit on the bench. Use the second towel to either constantly wipe the perspiration from your body to perspire faster and also to avoid having too much perspiration dripping onto the floor. Never place any towels over the floor heater. If your legs become cold, you can use a third towel to drape over your legs to trap the heat.
5. This is a non-commercial sauna. For every three hours ON, the sauna must be turned OFF for one hour to cool down.
6. At the first sign of a cold or flu, increasing your sauna sessions may be beneficial in boosting your immune system and decreasing the reproductive rate of the virus.
7. To help relieve sore and tense muscles, massage the affected areas during your sauna session.
8. To treat your ankles and feet more effectively, you can elevate them and move them close to one of the heat emitters to achieve a deep heating effect.
9. To utilize the sauna's heat therapy effect, put oil and treatment into your hair and wrap it with a towel. After your sauna session is over, rinse your hair thoroughly.
10. The peaceful and relaxed state rendered by a sauna session may help you to sleep easier and deeper.
11. To conserve energy consumption, please unplug your sauna when not in use – especially if you do not plan on using the sauna for an extended period of time.
12. After the sauna session is over, do not jump into the shower or bath immediately. Because your body was heated up during the sauna session, it will continue to perspire even after the heat emitters are off. Sit in the sauna with the door slightly opened and let your body cool down. Once your body has cooled down and you feel comfortable, you can exit the sauna. After about fifteen minutes and when your

body has completely cooled down, you can take a shower or bath to clean your body.

Safety Instructions

1. Read and follow all instructions carefully before using the sauna.
2. When assembling and using the electrical equipment, safety precautions should always be followed.
3. To reduce the risk of injury, do not allow children to use the sauna unless they are closely supervised at all times by an adult. Children should not use the sauna unless prescribed or advised by their medical doctor.
4. Do not use the sauna immediately following strenuous exercises. Wait at least 30 minutes to allow the body to cool down completely.
5. Pregnant or possibly pregnant women should contact their medical physician prior to using the sauna. Excessive temperatures have a high potential for causing fetal harm during pregnancy.
6. **Hyperthermia Danger:** The normal body temperature can't rise above 103°F (39°C). Symptoms of excessive hyperthermia include dizziness, lethargy, drowsiness, and/or fainting. The effects of excessive hyperthermia may include, but are not limited to failure to perceive heat, physical inability to exit the sauna, unawareness of impending hazards, unconsciousness, and/or fetal harm in pregnant women. Hyperthermia could make your body's core temperature rise. Setting the desired temperature to an excessively high temperature is not recommended.
7. The use of alcohol, drugs, or medications (prescribed or non-prescribed) prior to or during the sauna session may lead to unconsciousness and/or other harmful physical injuries.
8. Persons suffering from obesity or with a medical history of heart disease, low or high blood pressure, circulatory system problems, diabetes, or other medical conditions should consult with a medical physician prior to using the sauna.
9. Persons using medications should consult with a medical physician before using the sauna. Some medications may induce drowsiness while other may affect the heart rate, blood pressure, and/or blood circulation.
10. Use care when exercising before and after sauna use.
11. Never sleep inside the sauna
12. Do not use any type of cleaning agents on the interior of the sauna. Only wipe down the sauna room with water and a damp cloth. Never use any chemical based cleaners.
13. Do not stack or store any objects on top of or inside the sauna.
14. If the power supply cord becomes damaged, it must be replaced immediately by the manufacturer or its agent. If you find the power cord is too hot (normally it will become warm) or that the electrical equipment may be experiencing technical problems, please contact the manufacturer or its agent immediately to avoid hazardous situations.
15. Make sure that the electrical outlet is in good working order. A common problem with electrical outlets is loose wiring on the connection points of the terminals of the

outlet. A loose wire will also make for a bad connection and cause an unusual amount of heat buildup. Loose connections can also cause sparking in the junction box that can result in arcing. You'll likely see burn marks around the terminals if this occurs. If this happens, do not use the sauna and have the outlet replaced by a certified electrician. If the power cord is damaged, please contact Customer Support.

16. Do not use the sauna during an electrical storm to avoid risk of shock or injury.
17. Do not continuously switch the power ON and OFF excessively as it will compromise the life of the electrical components.
18. Your hands must be dry and free of moisture before plugging and unplugging cords and wiring harnesses from the power supply and circuit boards. Never operate the sauna with wet hands or wet feet to avoid the risk of electrical shock or injury. Never touch the metal prongs of the plug.
19. Do not attempt to make any repairs yourself unless authorized by the manufacturer or its agent. If a problem occurs with the sauna, please contact the manufacturer or its agent immediately to avoid safety risks. Unauthorized repair attempts will void the manufacturer's warranty.
20. Please make sure the outlet power supply meets the specifications required. Failure to meet the requirements may cause safety risks.
21. Some sauna models are equipped with reading and/or roof lamps. Because the lamp temperature will become very hot once powered ON, do not attempt to touch the lamp to avoid being burned. Do not attempt to touch it for at least 20 minutes or until it cools down completely if a need to touch it arises.
22. Do not pour water or any other liquids onto the infrared heat emitters. Do not bump, hit, or break the heating elements as it may cause an electrical short and pose a safety risk.
23. Do not make any modifications to the sauna, the sauna structure, or the sauna components.
24. Prior to each sauna session, the sauna room is to be inspected for correct operation. If for any reason your sauna does not seem to be operating properly, discontinue use and contact Customer Service.

Safeguards For Your Sauna

1. Do not install the sauna near water, near a bathtub (if water will splash on the sauna), near a shower (if water will splash on the sauna), in a wet basement, or near a swimming pool (if water will splash on the sauna).
2. Do not use liquid cleaners or aerosol cleaners on the sauna. Unplug the sauna from the wall outlet before cleaning. Use plain water and a soft damp cloth for cleaning.
3. The power supply cord should be routed so that it is not walked on or pinched by any object that may be placed against it.
4. When replacement parts are required, be sure they meet the specified requirements of the manufacturer. Unauthorized substitutes may result in a fire, electrical shock, or other hazardous situations. After any repairs, please ask the service technician to perform a safety check to determine that the sauna is in good

- working order.
5. Do not use any wall receptacle adapter, surge protector, or extension cord between the sauna cord and wall outlet.

Troubleshooting Guide

1. No Heat Coming From Some Of The Heat Emitters

Solution: Check to make sure all the heat emitter cords are properly connected, including the cord to the heat emitter underneath the bench (if applicable). Go to the roof, and also check that the heat emitter cords are properly connected to the cords on the roof and that those cords are properly plugged into the power supply.

Solution: If some of the heat emitters are working, then the ones which are not working may have been damaged. Do not continue to operate. Contact the manufacturer for replacement parts.

Solution: If the heat emitters are not working but the control panel displays the time and temperature, then the temperature sensor may not be plugged in properly or it may be damaged. Turn the control panel off and then go to the roof of the sauna and locate the red and black wires near the air vent towards the rear of the sauna. After you have located the red and black wires labeled “TEMP SENSOR”, disconnect them. Connect the spare temperature sensor. For testing purposes, insert the “TEMP SENSOR” (you just connected) down the vent on the roof so that it is now inside the sauna. Then go to the control panel and press the power button. If the heat emitters now have heat, then the “TEMP SENSOR” was the cause of the problem. You may have to wait about five minutes to confirm if the heat emitters are generating heat. Remove the original temperature sensor from its hole and replace it with the spare one.

2. Control Panel Malfunctioning

Solution: The control panel will turn on, but not off and the displayed numbers flash. The issue may be a connection problem. Go up to the roof and locate the “CTRL” wire harness you connected when the roof was installed onto the sauna room. Disconnect the “CTRL” wire harness, check the pins to make sure they are straight and not bent, and firmly reconnect the “CTRL” wire harness. Attempt to turn the sauna on at the control panel and check to see if the buttons are now responding. Contact the manufacturer for any additional troubleshooting.

Solution: The control panel will not turn off, the power/work/or heat lights do

not come on, or the temperature and timer buttons do not work means the control panel may have been damaged and will need to be replaced. Contact the manufacturer for additional troubleshooting.

3. Sauna Shows Signs Of No Power

Solution: There could be one of a few problems causing this. First, check to see if the cord from the power supply is plugged into the wall outlet. Also check your main circuit breaker to confirm that it has not tripped. Check the power supply on the roof of the sauna to make sure there are no signs of malfunctioning, such as a high temperature, burning odor, or strange sounds. Also, check to make sure none of the power cords are damaged. If the power supply is malfunctioning or power cords are damaged, then unplug the sauna immediately and contact the manufacturer.

Solution: If your sauna is plugged in and you have no power at the control panel, then the power supply may need to be reset. Go to the roof of the sauna and locate the power supply. Press the RESET button to reset the power supply. The RESET button is on the same side of the power supply as all the heater cord connections. Attempt to turn the sauna on at the control panel. Contact the manufacturer for any additional troubleshooting.

Solution: There could be damage to the temperature sensor. If your sauna arrived with a spare temperature sensor, turn the control panel off and go to the roof of the sauna and locate the red and black wire near the air vent towards the rear of the sauna. After you have located the red and black wires labeled "TEMP SENSOR", disconnect them. Connect the spare temperature sensor. For testing purposes, insert the "TEMP SENSOR" (you just connected) down the vent on the roof so that it is now inside the sauna. Then go to the control panel and press the power button. If the heat emitters now heat, then the temperature sensor was the cause of the problem. You may have to wait about five minutes to confirm if the heat emitters are generating heat. Remove the original temperature sensor from its hole and replace it with the spare one.

Solution: Check the wiring harnesses coming from the power supply located on the roof of the sauna. Make sure the wiring harness labeled "CTRL" is connected to the power supply at one end and connected to another wiring harness labeled "CTRL" at the other end. If this wiring harness is not properly connected, then the sauna will show signs of having no power.

4. CD Player Will Not Work

Solution: Check to make sure the lock screws on top of the radio have been removed. The CD player will not work if the screws are not removed.

Limited Lifetime Warranty

5 Year Limited Warranty*: Golden Designs, Inc. under the Dynamic brand name warrants the wood, structure, heating elements, and electronics against defects in material and workmanship for a period of 1 to 5 years from the original date of purchase. **This sauna is for INDOOR use only. Placing your sauna outdoors will VOID this warranty. Any damage due to exposure to outdoor elements such as rain, snow, sun, wind or extreme temperatures will not be covered by this warranty. Any damages as a result of modifications made to the sauna or its components will void this warranty.**

Extent of Warranty: This limited warranty applies to products manufactured or distributed by Golden Designs, Inc. under the Dynamic brand name, delivered in the continental United States or Canada and extends to the original purchaser at the original site of installation only. This warranty becomes valid at time of purchase and terminates either by specified time frame listed above, owner transfer, or relocation. **Your sales receipt showing the date of purchase of the product is your proof of purchase. Warranty is not transferable.**

Manufacturer Warranty

All Golden Designs, Inc. products are manufactured with the highest quality appliances and are warranted to be free from defects in material and workmanship at the time of delivery. The appliance warranty is extended through the manufacturer for the product including, but not limited to: stereos, CD/DVD players, etc. All exchanged parts and products replaced under this warranty will become the property of Golden Designs, Inc. Golden Designs, Inc. reserves the right to change manufactures of any part to cover any existing warranty. Any parts determined to be defective must be returned to Golden Designs, Inc. to obtain warranty service. You must prepay any shipping charges, export taxes, custom duties and taxes, or any other charges associated with the transportation of the parts. In addition you are responsible for insuring any parts shipped or returned. You must present Golden Designs, Inc. with proof of purchase documents (including the date of purchase). Any evidence of alteration, erasing or forgery of proof of purchase documents will be cause to **VOID** this limited warranty. Products on which the serial number has been defaced or removed is not eligible for warranty service. This warranty covers parts, but does not cover labor.

Warranty Limitations

This warranty does not apply if the unit has been subject to negligence, alteration, modification, misuse, abuse, repairs by non-Golden Designs, Inc. authorized personnel, inappropriate installations, or any case beyond the control of Golden Designs, Inc. invalidating this warranty including but are not limited to:

- Use of lacquer or paints
- Sauna and other Golden Designs, Inc. products accessories placed on non-approved surfaces

- Outdoor applications
- Normal wear and tear or weathering
- Use of product not in accordance with instructions
- Worn out receptacle

Surface cracks are not considered defects in material or workmanship, as they are normal characteristics of all woods. This includes minor cracks due to wood expansion and contraction. Note: Since the wood used in construction has been kiln dried, a certain amount of expansion and contraction occurs in the wood in a sauna environment.

Disclaimers

Golden Designs, Inc. shall not be liable for loss of use of sauna or other Golden Designs, Inc. products or other secondary or incidental or consequential costs, expense or damages - which may include the removal of permanent deck or other custom fixtures or the necessity for crane removal - arising directly or indirectly out of the use or inability to use the product. Any implied warranty shall have duration equal of the applicable warranty stated above. Under no circumstances shall Golden Designs, Inc. or any of its representatives be held liable for injury to any person or damage to any property, however arising. Specifications are subject to change without notice or obligation.

Legal Remedies

This limited warranty gives you specific legal rights. You may have other rights, which may vary from state to state.

Customer Service

For customer service, contact your authorized dealer. If you need additional information or assistance, please email Golden Designs, Inc. at info@goldendesignsinc.com or call (909) 212-5555.

*Limited Lifetime Warranty of Sauna Products is 5 years for residential use and 1 year for commercial use on heating elements and electronics from the date of purchase. The wood structure has a 1 year limited warranty.

WARRANTY CARD

Congratulations on your purchase of an Infrared Sauna from Golden Designs, Inc. Please take the time to complete the following Warranty Card and mail it back to:

**Golden Designs, Inc.
3550 Jurupa Street, Unit B
Ontario, CA 91761**

Please include a copy of your sales receipt showing date of purchase as this will serve as proof of purchase.

Warranty will be VOID if the following warranty card is not mailed back within 60 days of purchase date along with proof of purchase.

****Serial number (S/N) is located on the sauna’s front panel, rear panel, or on the carton.****

DETACH HERE



WARRANTY CARD

All fields must be completed to validate the warranty.

Name: _____

Address: _____

City: _____ State: _____ Zip Code: _____

Phone Number: _____

Purchase Date: _____

Purchase From: _____

Serial Number: _____

Serial Number: _____